

A

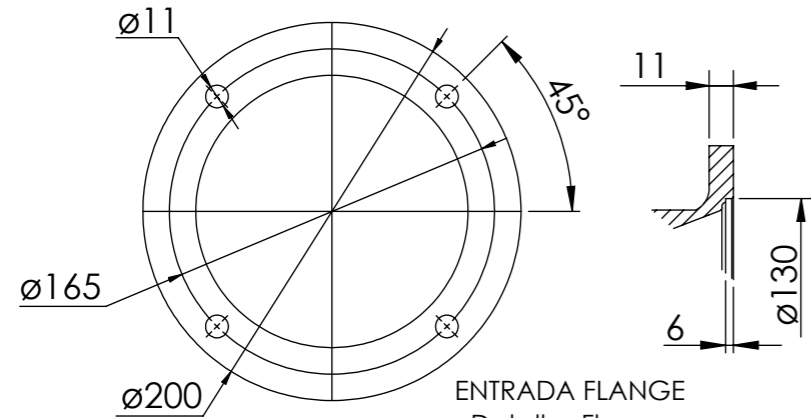

ENTRADA FLANGE
 Detalhe Flange
 Motor IEC Adapter Detail
 Detalle Brida
 (Sem escala/no scale/sin escala)

B

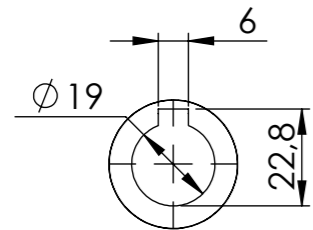

Detalhe entrada do motor
 Shaft motor detail
 Detalle entrada motor
 (Sem escala/no scale/sin escala)

C

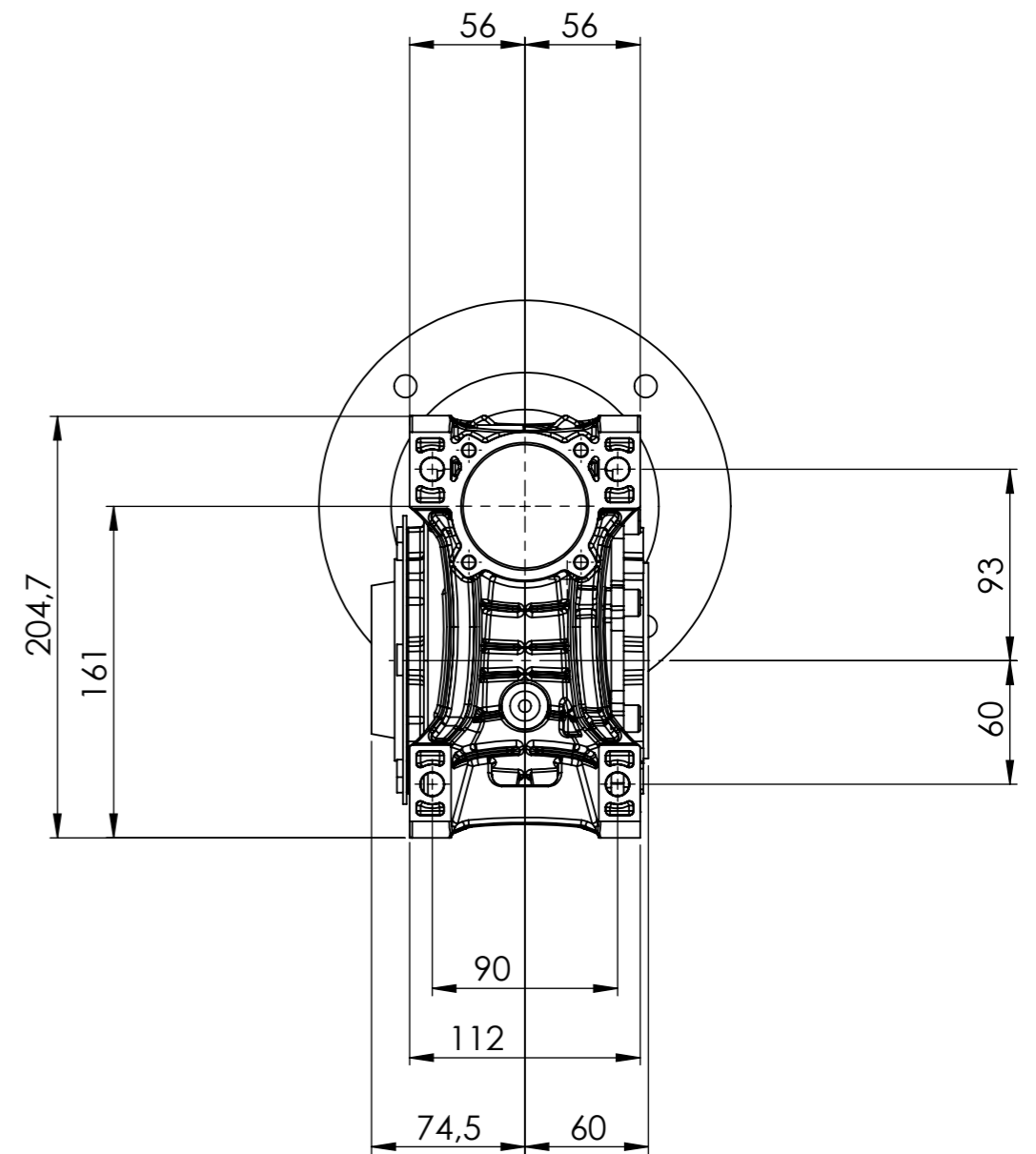
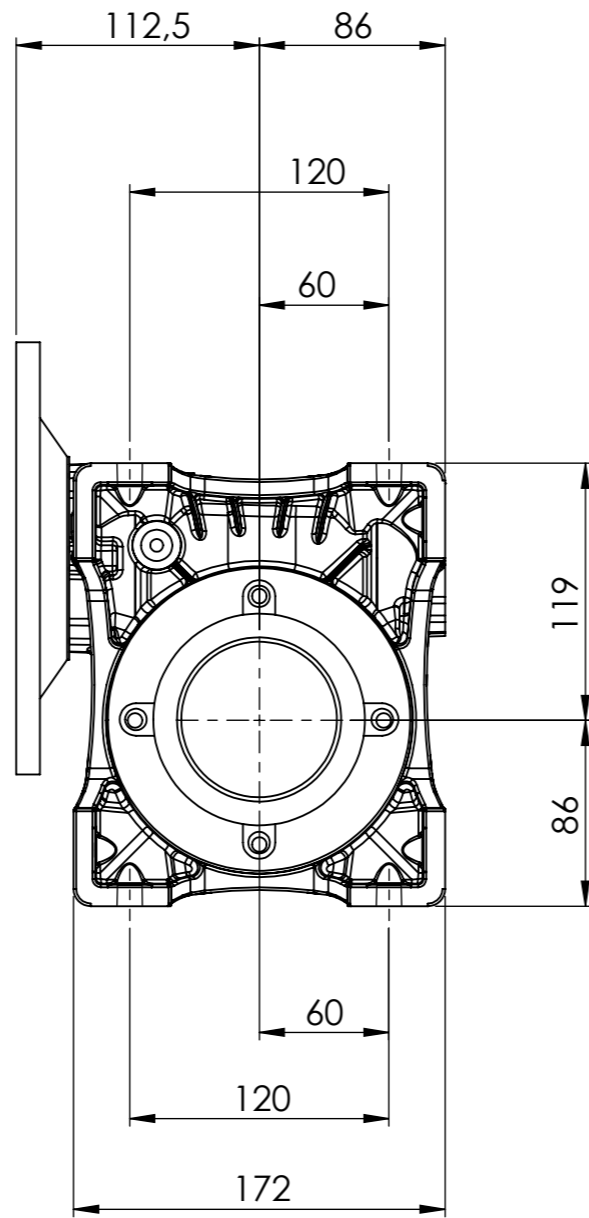

D

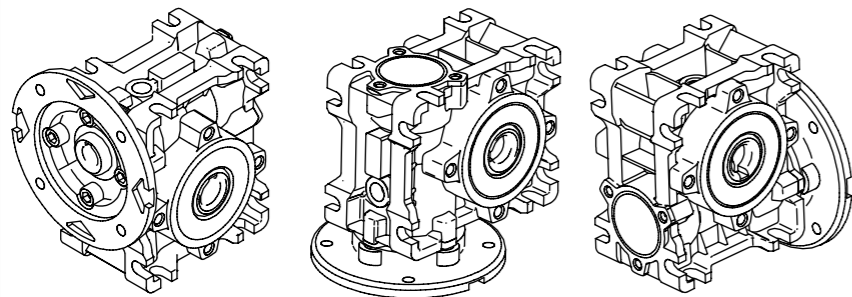

POSIÇÃO 1 POSIÇÃO 2 POSIÇÃO 3

E

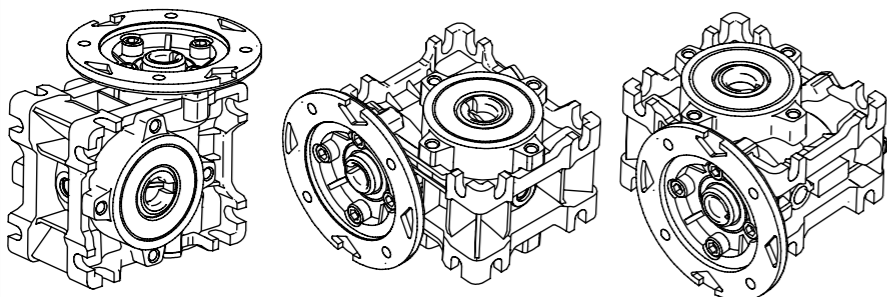

POSIÇÃO 4 POSIÇÃO 5 POSIÇÃO 6

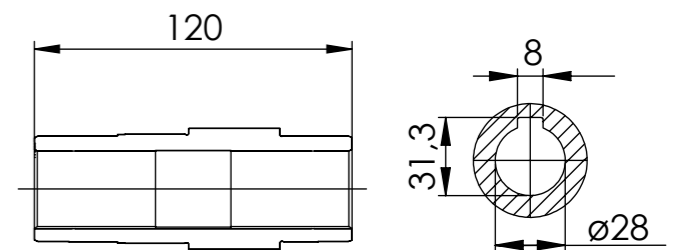

Detalhe eixo de saída
 Outup shaft detail
 Detalle del eje salida
 (Sem escala/no scale/sin escala)

MASSA BRUTA/GROSS WEIGHT		MASSA LÍQUIDA/NET WEIGHT		ESCALA/SCALE				
ECM	LOC	RESUMO DE MODIFICAÇÕES SUMMARY OF MODIFICATIONS		EXECUTADO EXECUTED	VERIFICADO CHECKED	LIBERADO RELEASED	DATA DATE	VER
EXEC		WCG01 75 1:100 NCH						
VERIF/CHECKED								
LIBER/RELEA SED DT LIBER/REL DT								
				FOL/SHEET 1 / 1				