

ENTRADA FLANGE
 Detalhe Flange
 Motor IEC Adapter Detail
 Detalle Brida
 (Sem escala/no scale/sin escala)

Detalhe entrada do motor
 Shaft motor detail
 Detalle entrada motor
 (Sem escala/no scale/sin escala)

Detalhe do eixo de saída
 Output Shaft detail
 Detalle del eje de salida
 (Sem escala/no scale/sin escala)

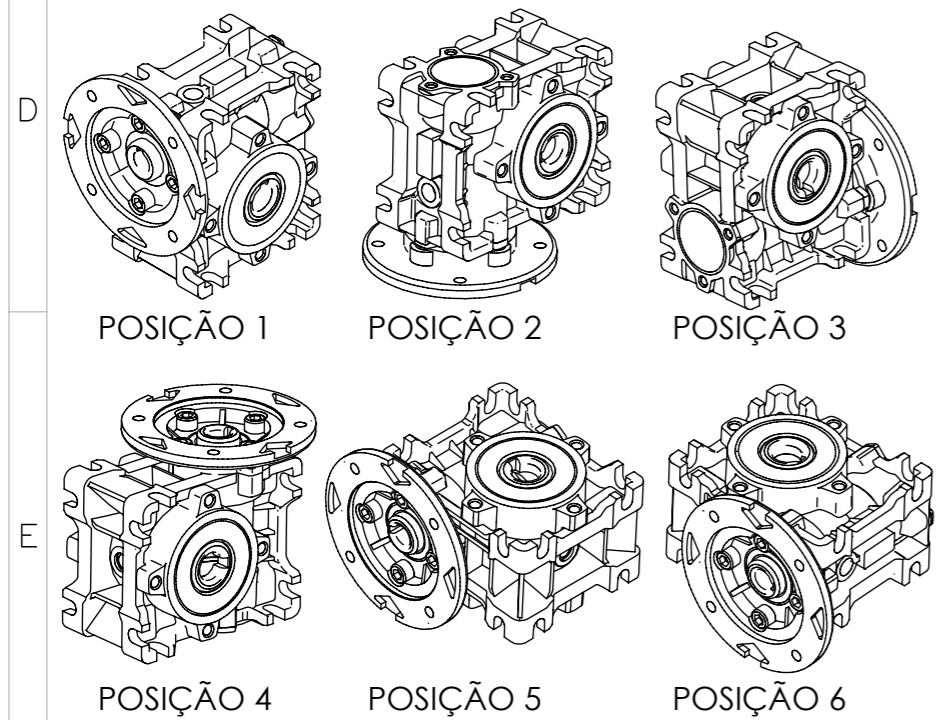

MASSA BRUTA/GROSS WEIGHT		MASSA LÍQUIDA/NET WEIGHT		ESCALA/SCALE				
ECM	LOC	RESUMO DE MODIFICAÇÕES SUMMARY OF MODIFICATIONS		EXECUTADO EXECUTED	VERIFICADO CHECKED	LIBERADO RELEASED	DATA DATE	VER
EXEC		WCG01 63 1:40 NAJ						
VERIF/CHECKED								
LIBER/RELEASED								
DT LIBER/REL DT				FOL/SHEET 1 / 1				

