

ENTRADA FLANGE  
 Detalhe Flange  
 Motor IEC Adapter Detail  
 Detalle Brida  
 (Sem escala/no scale/sin escala)

Detalhe entrada do motor  
 Shaft motor detail  
 Detalle entrada motor  
 (Sem escala/no scale/sin escala)

Detalhe do eixo de saída  
 Output Shaft detail  
 Detalle del eje de salida  
 (Sem escala/no scale/sin escala)

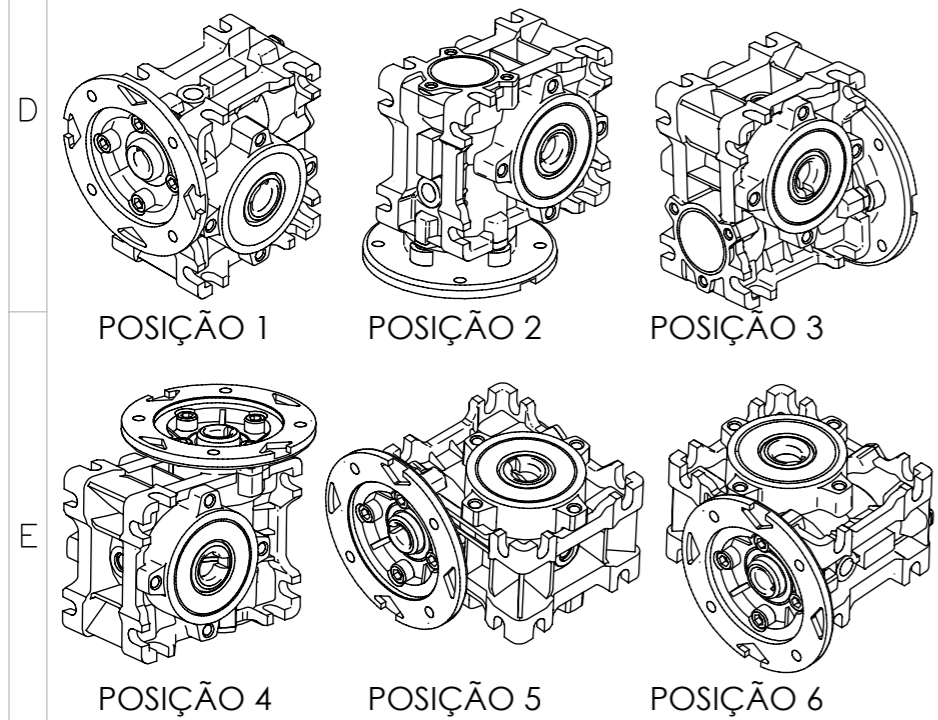

MASSA BRUTA/GROSS WEIGHT		MASSA LÍQUIDA/NET WEIGHT		ESCALA/SCALE				
ECM	LOC	RESUMO DE MODIFICAÇÕES SUMMARY OF MODIFICATIONS		EXECUTADO EXECUTED	VERIFICADO CHECKED	LIBERADO RELEASED	DATA DATE	VER
EXEC		<b>WCG01 63 1:60 NAJ</b>						
VERIF/CHECKED								
LIBER/RELEA SED DT LIBER/REL DT								
				FOL/SHEET 1 / 1				

