

Propriedade da WEG-CESTARI. Proibida a reprodução ou uso sem autorização prévia.  
 Property of WEG-CESTARI. Prohibited reproduction or use without previous authorization.  
 Propriedad WEG-CESTARI. Prohibida la reproducción o uso sin permiso.

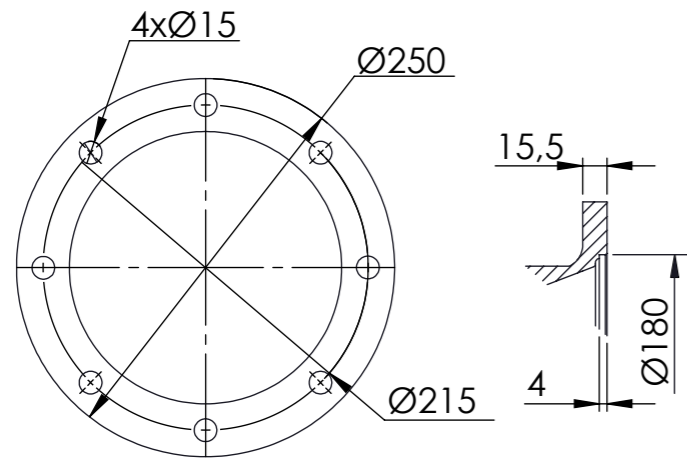

ENTRADA FLANGE  
 Detalhe Flange Lanterna  
 Motor IEC Adapter Detail  
 Detalle BridaLanterna  
 (Sem escala/no scale/sin escala)

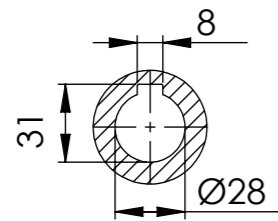

Detalhe entrada do motor  
 Shaft motor detail  
 Detalle entrada motor  
 (Sem escala/no scale/sin escala)

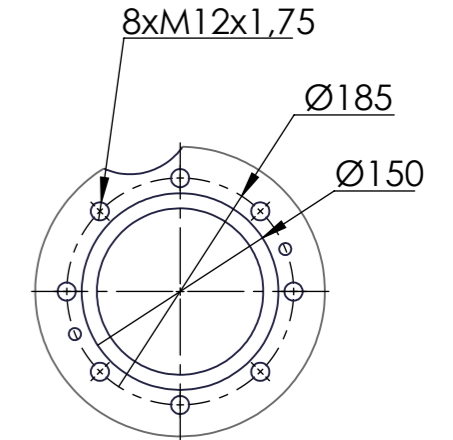
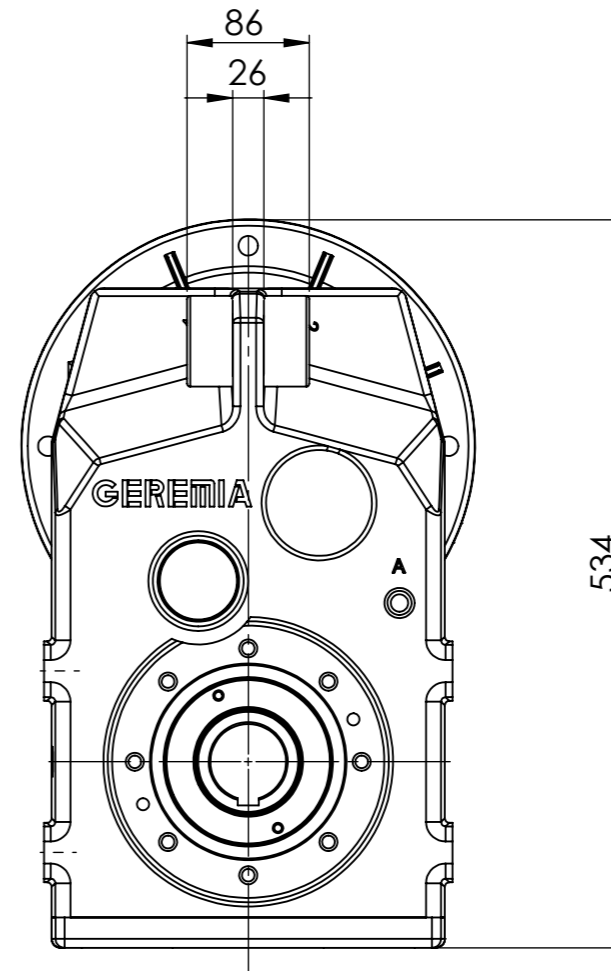
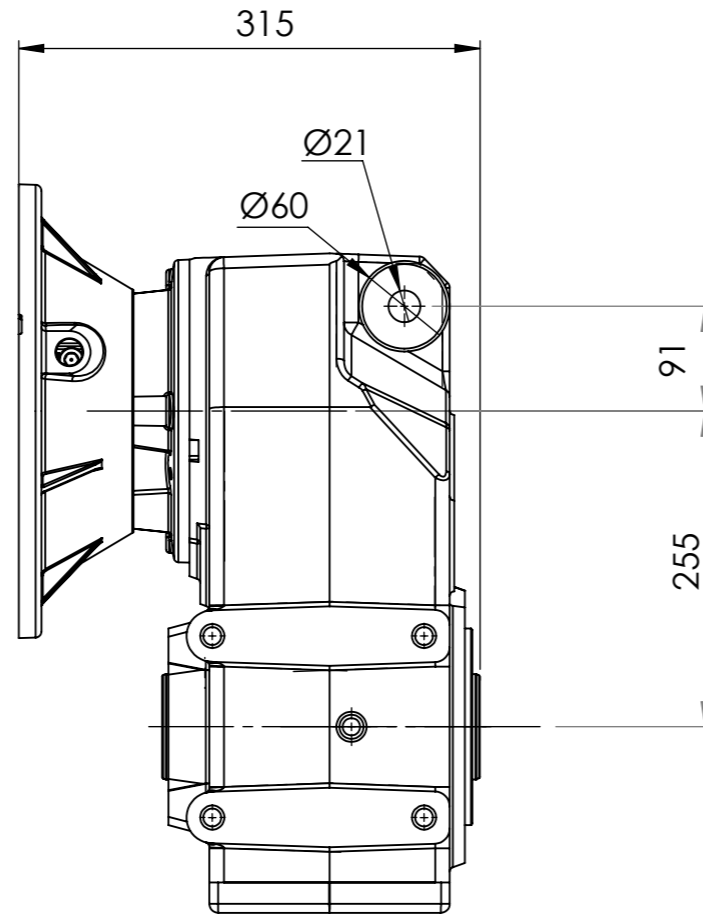

Detalhe da fixação da saída  
 (Sem escala/no scale/sin escala)

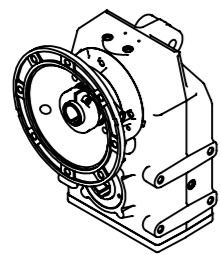

POSIÇÃO 1

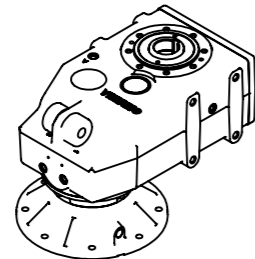

POSIÇÃO 2

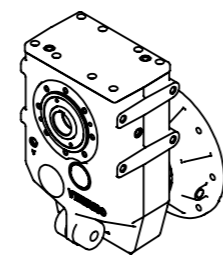

POSIÇÃO 3

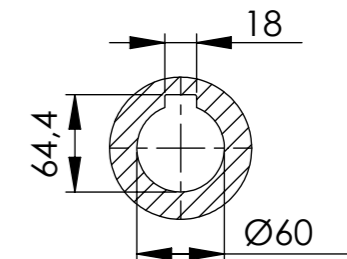
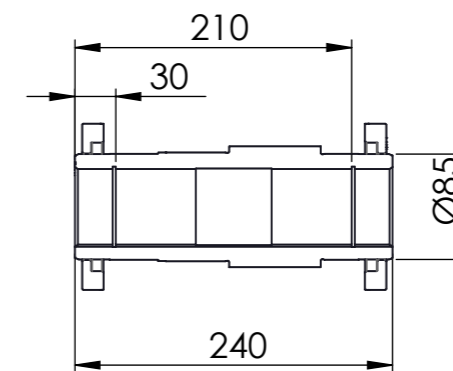

Detalhe do eixo de saída  
 (Sem escala/no scale/sin escala)

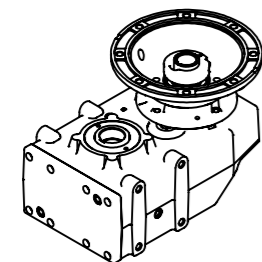

POSIÇÃO 4

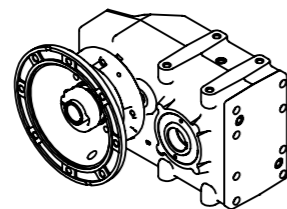

POSIÇÃO 5

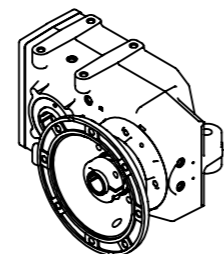

POSIÇÃO 6

\*Vistas das posições sem o motor.

\*Dimensões em mm/Dimensions in mm/Dimensiones en mm

Denominação Name Denominacion	<b>WEG CESTARI</b> REDUTORES	
<b>DIMENSIONAL</b>	Escala/Scale/Escala S/ ESC.	
<b>GD</b>	Desenho N° Drawing N° Diseño N°	
	GD60 3 BCC 112M	

Versão-0